

user manual

oliso[®]

mini
project iron™

hello

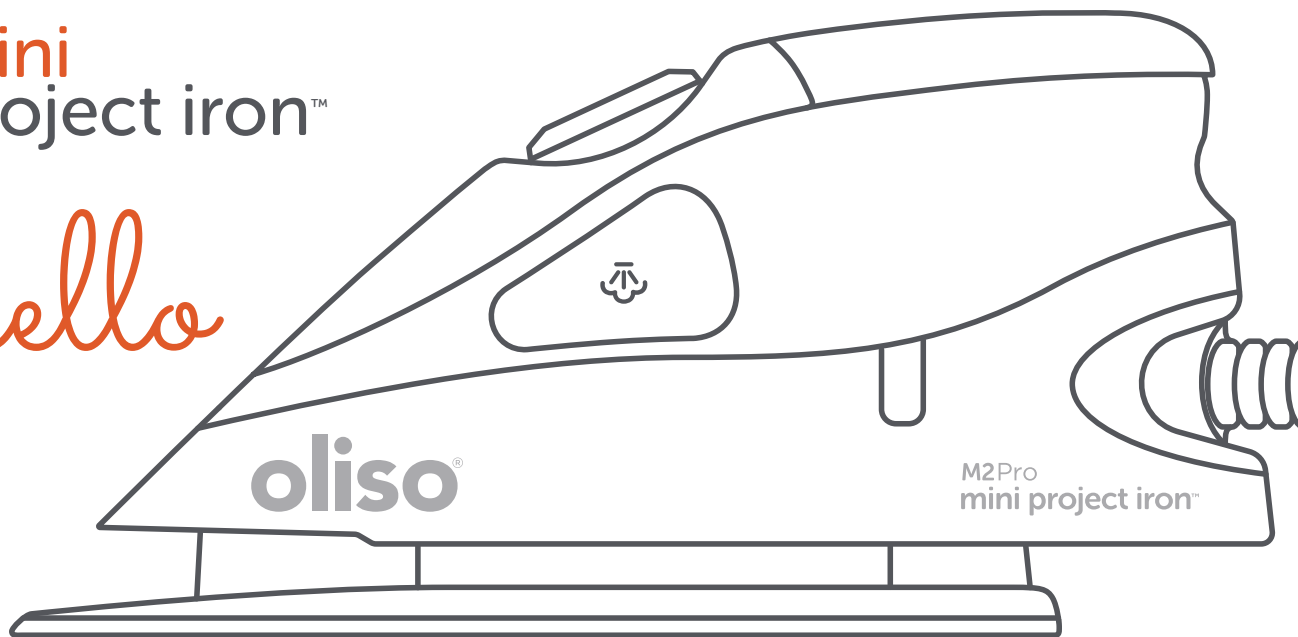

for model M2Pro

all-guides.com

important safety instructions

When using your iron, basic safety precautions should always be followed, including the following:

read all instructions before using this product

- 1 Use iron only for its intended use.
- 2 To protect against a risk of electric shock, do not immerse the iron in water or other liquids.
- 3 The iron should always be turned to "OFF" before plugging or unplugging from the outlet. Never tug cord to disconnect from the outlet; instead, grasp plug and pull to disconnect
- 4 Do not allow cord to touch hot surfaces. Let iron cool completely before putting away. Loop cord loosely around iron and/or soleplate when storing.
- 5 Always disconnect iron from electrical outlet when filling with water or emptying and when not in use.
- 6 The iron is not to be used if it has been dropped, if there are visible signs of damage, or if it is leaking.
- 7 Do not operate iron with a damaged cord or if the iron has been dropped or damaged. To avoid the risk of electric shock, do not disassemble the iron. Take it to a qualified serviceperson for examination and repair. Incorrect reassembly can cause a risk of electric shock when the iron is used.
- 8 Do not leave iron unattended while connected or on an ironing board.
- 9 This appliance is not intended for use by persons (including children) with reduced physical, sensory or mental capabilities, or lack of experience and knowledge, unless they have been given supervision or instruction concerning use of the appliance by a person responsible for their safety.
- 10 Children should be supervised to ensure that they do not play with the appliance.
- 11 Burns can occur from touching hot metal parts, hot water, or steam. Use caution when you turn a steam iron upside down - there may be hot water in the reservoir. (*see illustration -->)
- 12 If the iron is not operating normally, disconnect from the power supply and have the iron serviced by a qualified serviceperson.
- 13 When placing the iron on its soleplate™, ensure that the surface on which the soleplate™ is placed is stable.
- 14 When operating the iron, do not attempt to place vertically on its heel for resting. Use its soleplate™

***correct hand positioning**



incorrect hand positioning



(Burn warning)
Do not allow fingers to touch soleplate while hot.

special instructions

- 1 Oliso® irons are high wattage appliances - Please switch your iron to your country's voltage. To avoid a circuit overload, do not operate another high wattage appliance on the same circuit.
- 2 If an extension cord is absolutely necessary, a 10A cord should be used. Cords rated for less amperage may overheat. Care should be taken to arrange the cord so that it cannot be pulled or tripped over.
- 3 This iron uses hot steam! Be sure to let iron cool before refilling or storing.
- 4 Never direct fill the iron from a water tap while the iron is plugged into a power source. Soak up any excess water around iron (including power cord) before plugging back into an outlet.
- 5 Be sure dual voltage selector is in correct voltage position before operating. Before plugging in, read the information about dual voltage operation contained in the instructions section of the manual.
- 6 This appliance was set at the factory to operate at 120 volts. Refer to the Operating Instructions section of this manual for conversion to 220-240 volt operation.
- 7 **FOR HOUSEHOLD USE ONLY.**

please save these instructions

side view

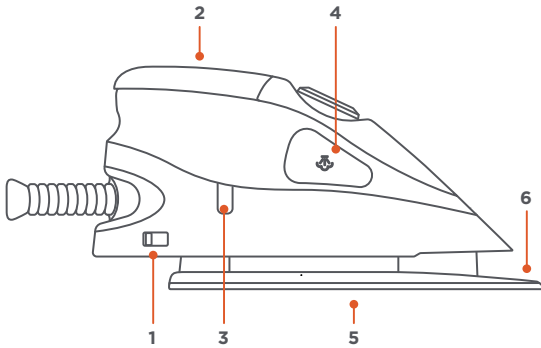

top view

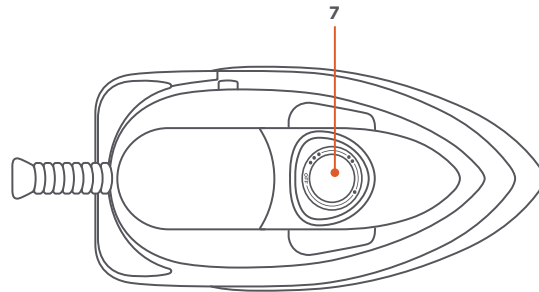

solemate™

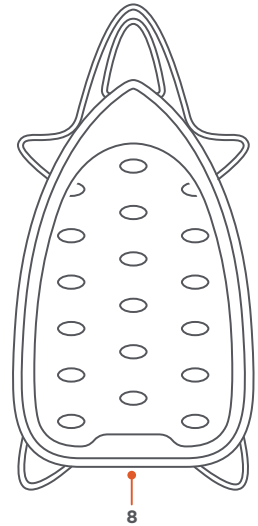

get to know your oliso® mini project iron®



1 Dual Voltage System
120V | 240V



3 sight window



5 soleplate



7 fabric selector



2 top fill water tank



4 one-press steam control



6 detailer tip



8 solemate™

4 simple steps to start

step 1

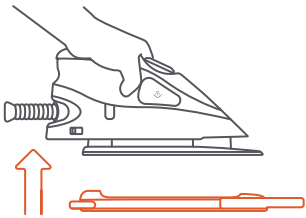
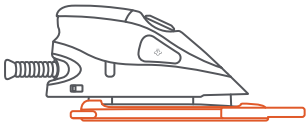

remove solemate™

Make sure to remove the solemate™ from the iron's soleplate before turning on iron.

step 2

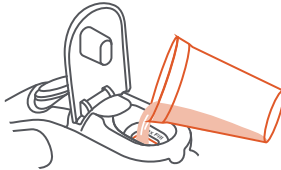

fill unplugged

Open the water tank lid and add water to max fill line with cup or directly from a faucet. 50mL equals max capacity.
Note: fill cup not included.

step 3

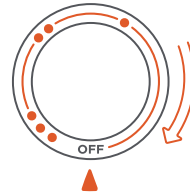
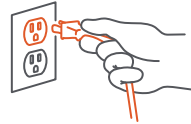

set up

Plug in. Turn dial clockwise to choose desired fabric setting.

Note: light will pulsate until temp is reached.

step 4

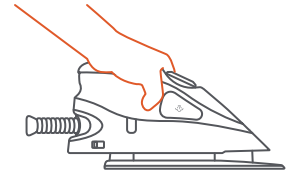
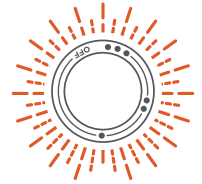

iron

When the light stops pulsating and is solid, the iron is ready for use.

Note: rest iron on solemate™ when not in use.

All manuals and user guides at all-guides.com

filling water tank

step 1

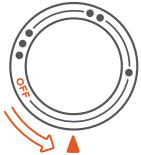

switch off
(turn the dial counter clockwise)

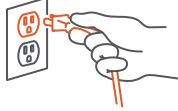

unplug iron

step 2



open lid

Place the warm iron on the solemate™ while it cools. Then open lid.

step 3

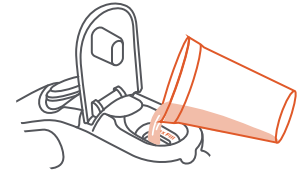

fill

50mL equals the max capacity of the water tank.
Note: fill cup not included.

max fill line

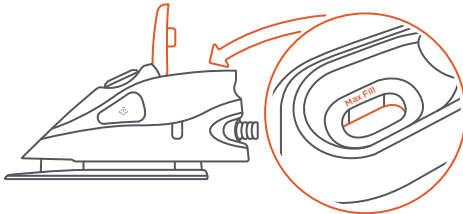

DO NOT

Do not fill the tank past the **MAX** fill line on the top of the iron. Close the lid when done.

alternative filling

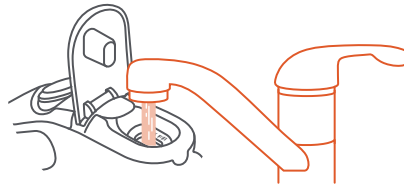

Alternatively, fill directly from a faucet holding the iron horizontally. Make sure iron is unplugged.

If iron is over-filled wipe up excess water around the iron before plugging the iron back in.

water recommendations

This iron is designed to be used with regular tap water. If your water is over 12 grams of hardness, we recommend using either inexpensive bottled spring water or mixing half tap water with half distilled water.

fabric selector

fabric selector

Turn the temperature + fabric selector to desired setting.

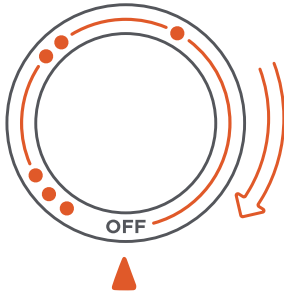

settings	temperature + fabric
OFF	—
●	low temp (synthetic)
● ●	medium temp (wool + silk)
● ● ●	high temp (linen + cotton)

status light

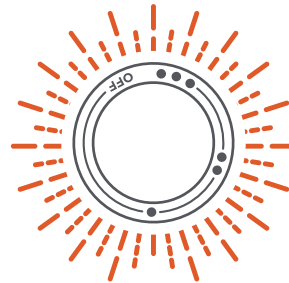

fabric selector dial status light

settings	heating	ready
OFF	—	solid
●	pulsating	solid
● ●	pulsating	solid
● ● ●	pulsating	solid



steam button status light

settings	heating	ready
OFF	—	—
●	—	—
● ●	OFF	solid
● ● ●	OFF	solid

Note: to use steam burst, the temperature must be set to the (●●, ●●●) range.

all-guides.com

steam button

voltage

one-press burst of steam

Fill with water (see page 5) and allow the iron to heat up (**solid light**) before pressing the steam button.

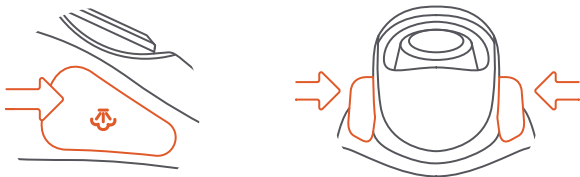

Press the burst of steam buttons and place the iron a few inches away from the garment to avoid damaging delicate fabrics.

The iron can only produce steam when the fabric selector knob is set to (••, •••) range.

horizontal burst

press steam buttons in



For a strong burst of steam from the soleplate.

voltage settings

This iron is set at the factory to operate at 120 volt.

110/120V



If set at **120V**, the iron will operate at 110 to 120V.

220/240V



If set at **240V**, the iron will operate at 200 to 240V.

Note: if necessary, check that you are using an adapter which meets the safety requirements of the country you are in.

IMPORTANT Switching voltage

Adjust the iron to correct voltage for your location, using a small flat object (flat-head screwdriver).

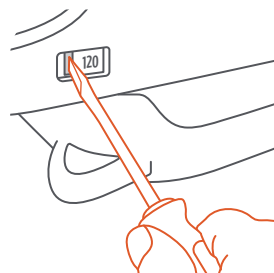

place small flat object here

solemate™

dual purpose solemate™

side 1

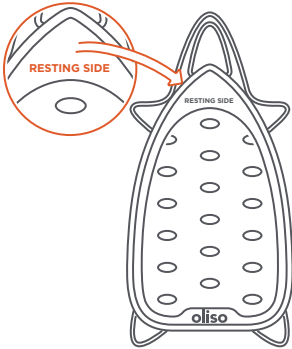

resting side

Lets the hot soleplate safely rest every time during ironing and protects fabrics.



side 2

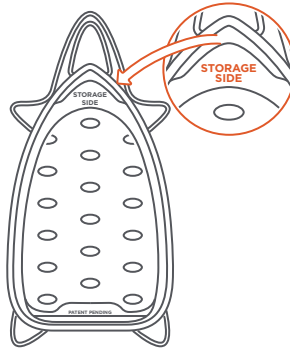

storage side

Easily snaps to the soleplate for easy transportation + storage.

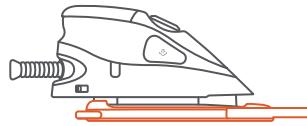

attaching solemate™

Note: allow soleplate to cool thoroughly before attaching solemate™

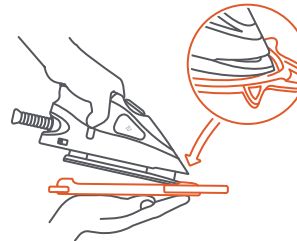

step 1

Insert front of soleplate into front of solemate™

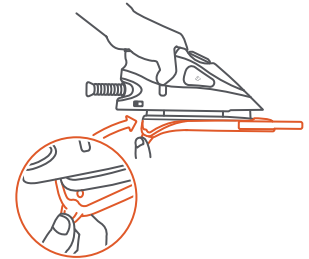

step 2

Wrap back tabs around soleplate

remove solemate™



Pull down on tab at back of solemate™ and remove

store iron properly

step 1

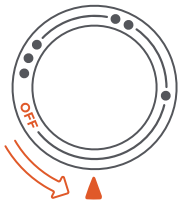

switch off
(turn the dial counter clockwise)

step 2

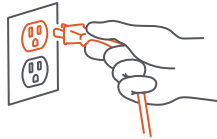

unplug iron
Iron should remain unplugged when not in use.

step 3

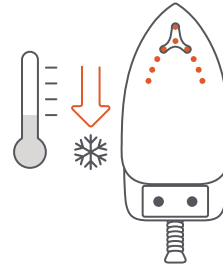

let cool off
Allow soleplate to cool thoroughly, then attach solemate™ (see page 8)

step 4

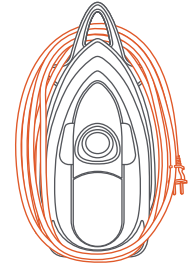

wrapping cord
For easy storage, the power cord can be wound loosely around the iron once it has cooled. Hook allows for easy hanging storage.

trouble shooting guide

problem	things to check	solution
Iron does not heat	Is fabric selector set to off?	Turn the fabric selector knob to a fabric setting.
	Is iron plugged in correctly?	Check to make sure the plug is fully plugged into a working power outlet. Also make sure that there are not other appliances which could overload the power outlet.
Iron produces little or no steam	Is there enough water in the tank?	Check "sight window" on the side of the iron to see if there is water in the tank. If you don't see water in the tank you can also check by unplugging the iron & letting it cool. Place the iron on the resting side of the solemate™ on a secure surface. Carefully open the lid on the top fill water tank to check the water level. Top off the water level as needed, not going over the max fill on the plastic housing.
	Is iron hot enough?	The fabric selector must be set to (•• or •••) to produce steam. Wait until the lights on the "one-press steam control" activate to let you know that the soleplate is warm enough to make a good solid steam burst.
	Are you pressing the steam buttons?	The iron can only produce steam when the fabric selector knob is set to (••, •••) range.
	Did you let your iron rest?	If your iron has been on a long time (excess of half hour) without steam use, please let your iron rest (unplugged) for about 5 to 10 minutes. This will allow steam to produce.

maintenance + cleaning

Always clean the soleplate of a steam iron when it is cool.

The soleplate should be cleaned if starch or other residue builds up. When the iron is cool, wipe the soleplate with a soft, damp cloth. Or purchase commercially available soleplate cleaner and follow the instructions according to the manufacturer.

Do not use abrasive cleaners or scouring pads as this will damage the iron's soleplate and its coating.

Mineral deposits from tap water can occur in the soleplate vents. To clean, fill the water tank and heat the iron to the highest (•••) setting. Once the iron is fully heated, unplug the iron and hold over a sink. Press the steam button repeatedly until water begins to drip out of the soleplate. Be careful, as this creates large amounts of steam.

Do not use any heavy duty cleaning or descaling products, such as abrasive sponges.

Never hold iron under a running tap while plugged into the wall. Be sure the iron is cold before filling and if you spill water by overfilling, be sure to dry off iron with a cloth before plugging the iron back into the outlet.

Be sure to rest iron on soft surface that will not burn, such as our solemate™, during use and storage. Be careful of the iron's hot surface until it cools.

It is best to empty the water tank after you finish ironing. Let water cool before emptying.

Make sure the iron is cool before storing it.

Clean solemate™ by using water & soft dish soap. Let dry before installing onto iron. Solemate™ is dishwasher safe.

If any problem persists, **contact our customer service**

1-800-899-5157 or customerservice@olis.com

warranty

Oliso warrants that for a period of three years (mini project iron™) from the date of the original purchase, this product will be free from defects in material and workmanship, when utilized for normal household use. Oliso will repair or replace this product or any component of the product found to be defective during the warranty period without charge to the customer. If a replacement product is sent, it will carry the remaining warranty of the original product.

Replacement will be made with a new or remanufactured product or component. If the product is no longer available, replacement may be made with a similar product of equal or greater value. This is your exclusive warranty.

This warranty is valid for the original retail purchaser from the date of initial retail purchase and is not transferable. Keep the original sales receipt. Proof of purchase is required to obtain warranty performance. Oliso dealers or retail stores selling oliso products do not have the right to alter, modify or in any way change the terms and conditions of this warranty.

The liability of oliso is limited solely to the cost of repair or replacement of the product at its option. This warranty does not cover normal wear of parts and does not apply to any product that has been tampered with or used for commercial purposes. This warranty does not cover damage caused by misuse, abuse, use on improper voltage or current, use contrary to the operating instructions, negligent handling or damage due to faulty packaging or mishandling in transit. This warranty does not cover damage or defects caused by or resulting from damages from shipping or repairs, service or alteration to the product or any of its parts, which have been performed by a repair person not authorized by oliso. Further, the warranty does not cover Acts of God such as fire, flood, hurricanes, and tornadoes.

This warranty is extended to the original purchaser of the product and excludes all other legal and/or conventional warranties. The responsibility of oliso is limited to the specific obligations expressly assumed by it under the terms of the limited warranty. In no event shall oliso be liable for any incidental or consequential damages caused by breach of any express, implied or statutory warranty or condition.

Except to the extent prohibited by law, any implied warranty or condition of merchantability or fitness for a particular purchase is limited in duration to the duration of the above warranty. oliso disclaims all other warranties, conditions, or representations, express, implied, statutory or otherwise. In no event shall oliso be liable for any indirect, special, incidental or consequential losses or damages (including but not limited to interruption of business or loss of business or profit) resulting from the use of or inability to use the product, any breach of contract, fundamental or otherwise, or for any claim brought against purchaser by any other party. Some states or jurisdictions do not allow the exclusion or limitation of incidental or consequential damages or limitations on how long an implied warranty lasts, so the above limitations or exclusion may not apply to you. If you have any question regarding this warranty or would like to obtain warranty service, please email oliso at customerservice@oliso.com, and a service center address will be provided to you.

Please note: Your oliso® mini project iron™ may look slightly different than the irons illustrated here.
For a complete review of current oliso® mini project iron™ models, please visit oliso.com

For more information visit

oliso.com     

we'd love to hear from you!

8:30am - 4:30pm (Pacific) Monday-Friday 1-800-899-5157
or mail us at 1200 Harbour Way S, STE 215, Richmond, California, 94804, USA.

customerservice@oliso.com

all-guides.com

thanks

for purchasing the

oliso[®]

mini
project iron[™]

reinvented *for you*[™]